

MFOS 12 Channel Vocoder

Designed and Drawn by Ray Wilson

1013 Hz Band-Pass, $G = -2.8$, $Q = 3.9$

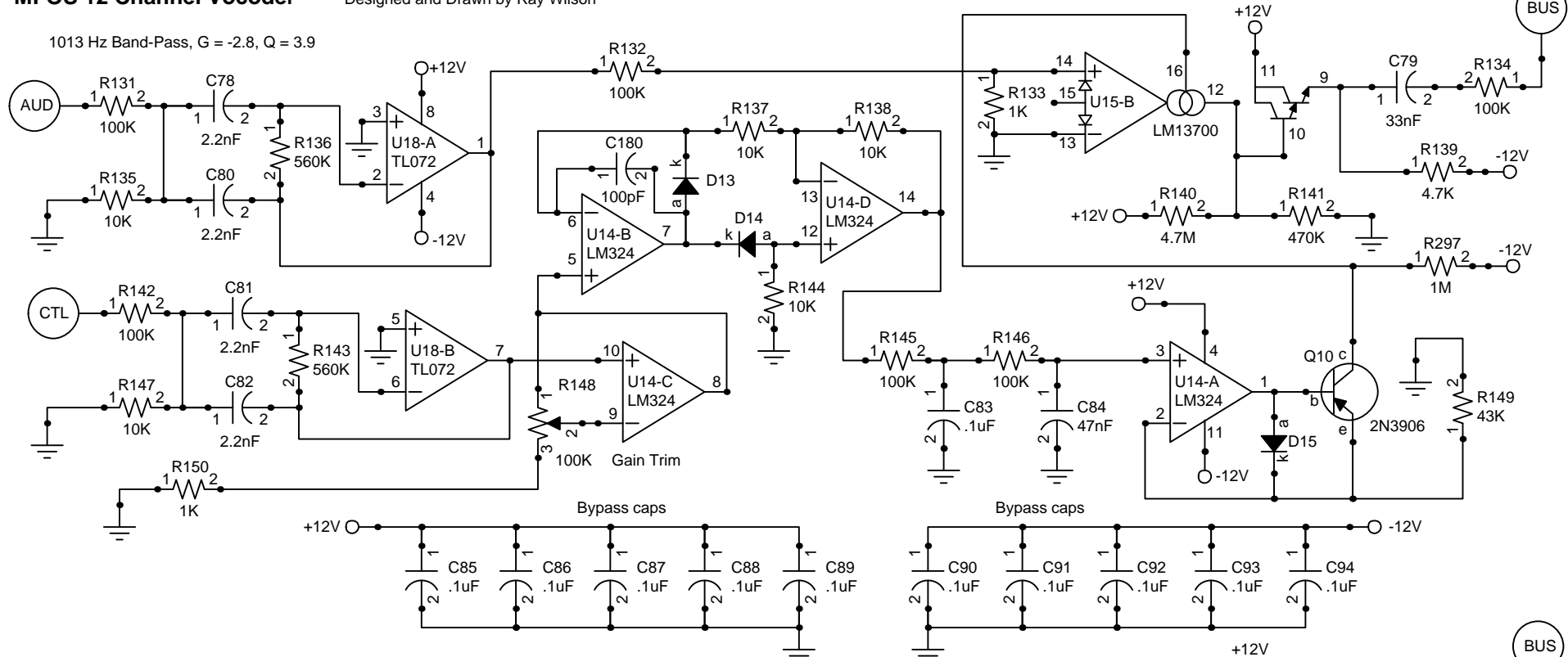

720 Hz Band-Pass, $G = -2.8$, $Q = 3.7$

